

**WELCOME!**

**Welcome to DES  
&  
to Today's Workshop  
“Pollution Prevention &  
Household Hazardous Waste”**

# WHY ARE YOU HERE?

- **Required by law and NH Solid Waste Rules.**
- **Build your resume & accumulate professional development hours.**

# WHY THIS WORKSHOP?

## P2 & HHW

- Provide you with more information on HHW
- Introduce the concepts of preventing pollution
- Offer suggestions on how to educate customers on making better choices



# TODAY'S AGENDA

- **What is P2?**
- **CD Cover Game**
- **How to Implement P2 at SW Facilities**
- **What to do with your Gifts?**
- **Climate Change? Why be prepared?**
- **Educating Your Customers on HHW**
- **Alternatives to “Off the Shelf” Products**



NEW HAMPSHIRE  
POLLUTION PREVENTION PROGRAM

# New Hampshire Pollution Prevention Program

# What is Pollution Prevention?





- ▶ Free
- ▶ Confidential
- ▶ Non-enforcement
- ▶ Pollution prevention and compliance assistance program available to all NH businesses, institutions, municipalities and agencies.

# Pollution Prevention

Reducing or eliminating waste at the source...

Instead of managing that waste after it is generated.

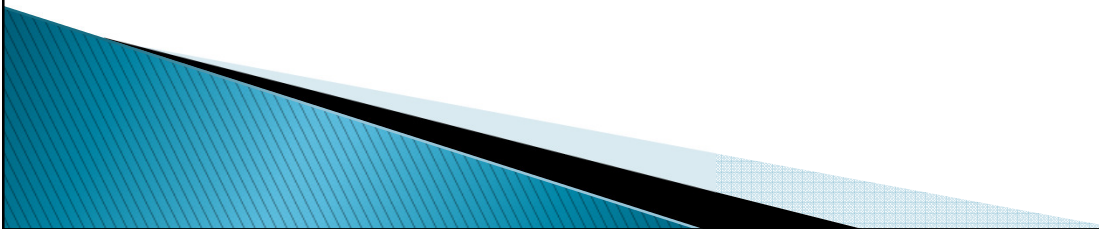



# Pollution Prevention Hierarchy

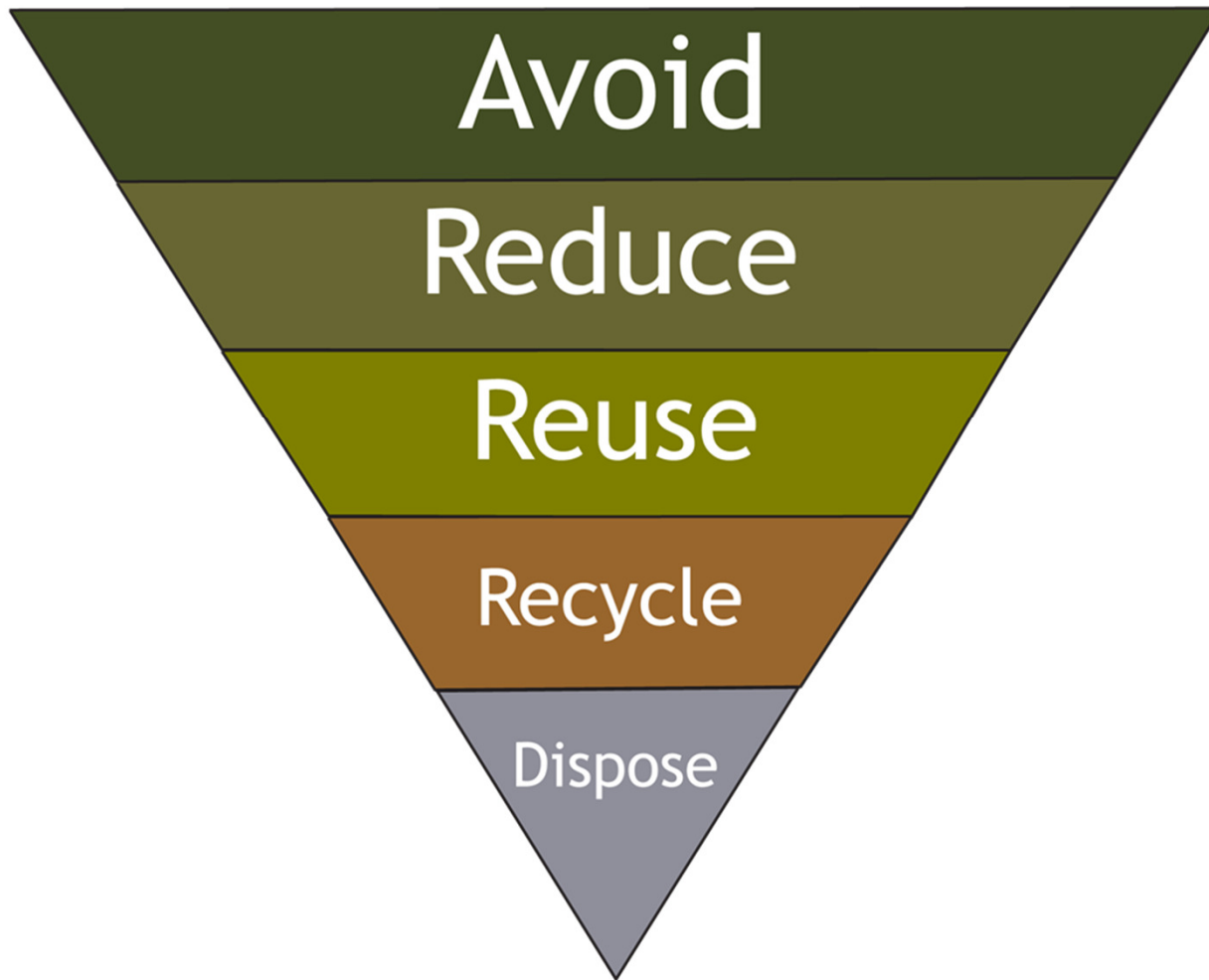

# Dispose



# Recycle



# ALUMINUM CAN RECYCLING

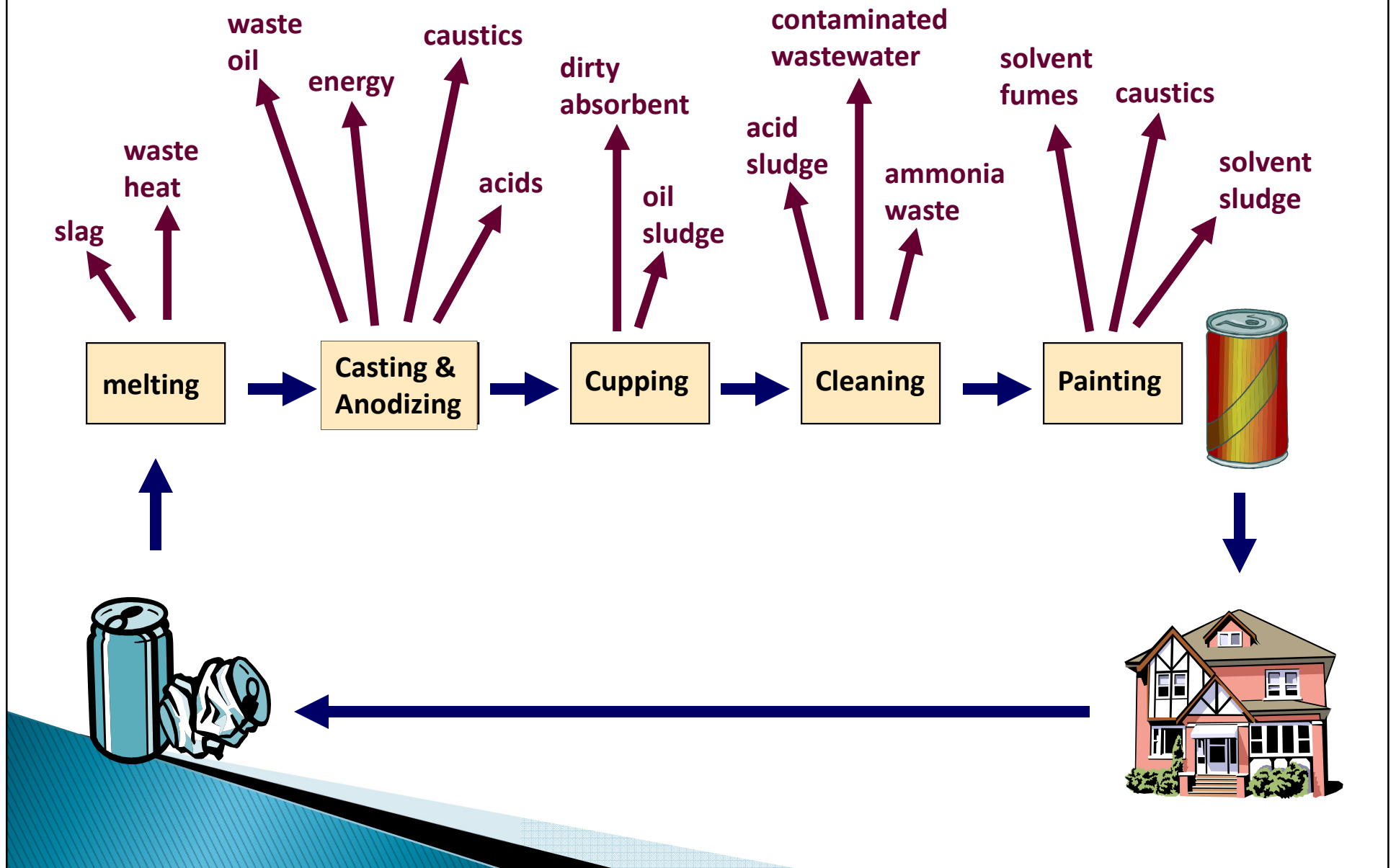

# Is recycling bad?

Because it is a manufacturing process that generates waste?



# Recycling is good!

- ▶ Making a can from a can saves energy and resources.
- ▶ 80% of the energy that goes into making a can comes from the extraction of the ore.

# Reuse



# Reuse





# Bicycle Materials, Wastes, and By-Products

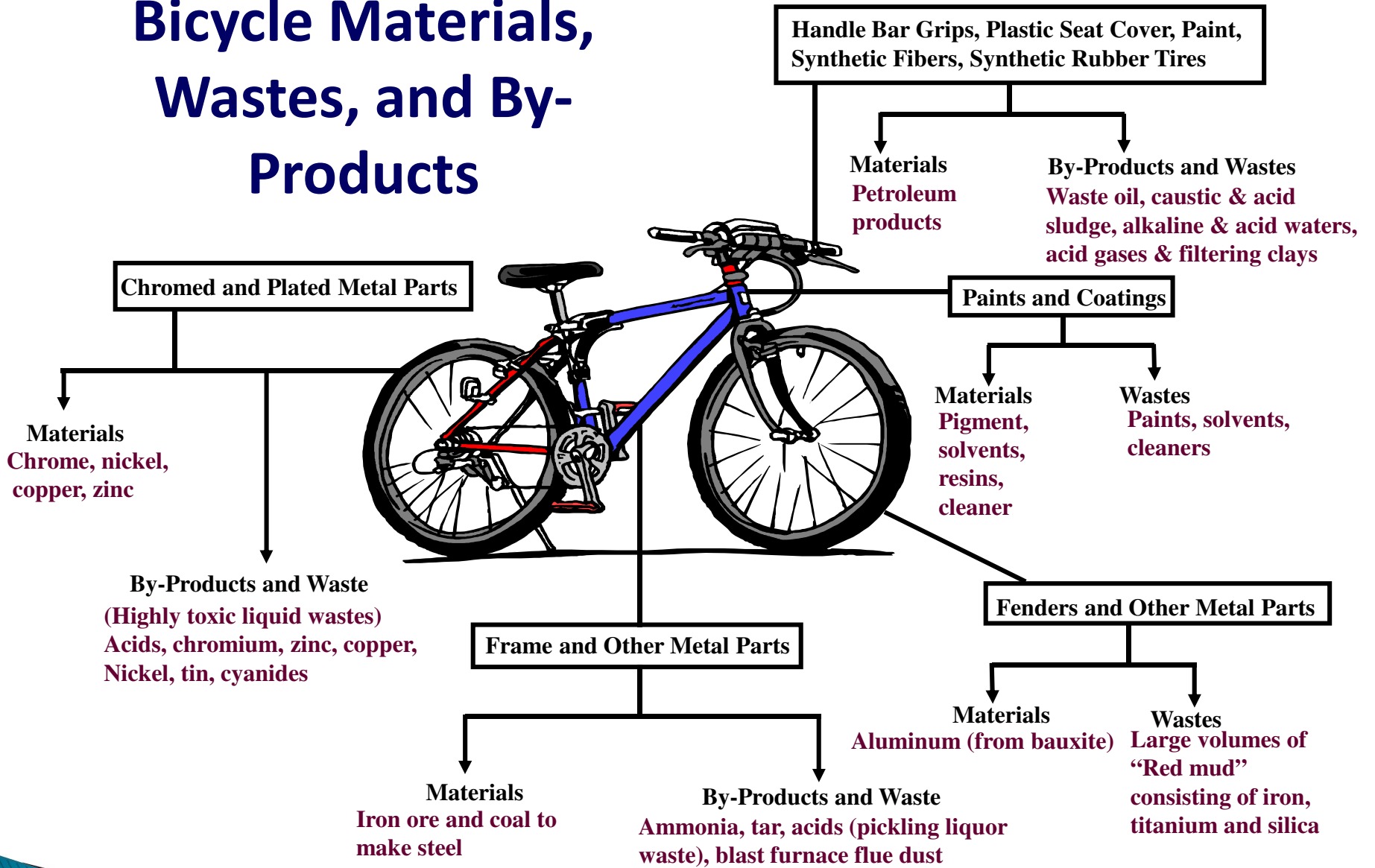

# Reuse

.....even better than Recycling

Reusing a product eliminates the need to manufacture a new product.

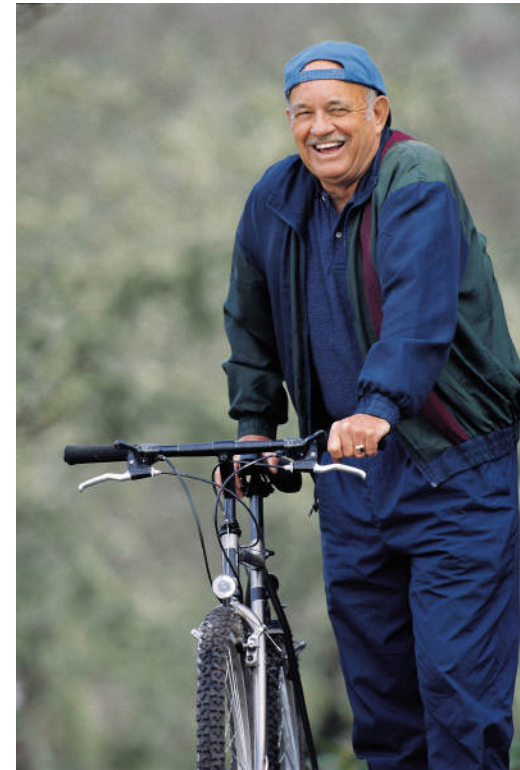

# Reduce

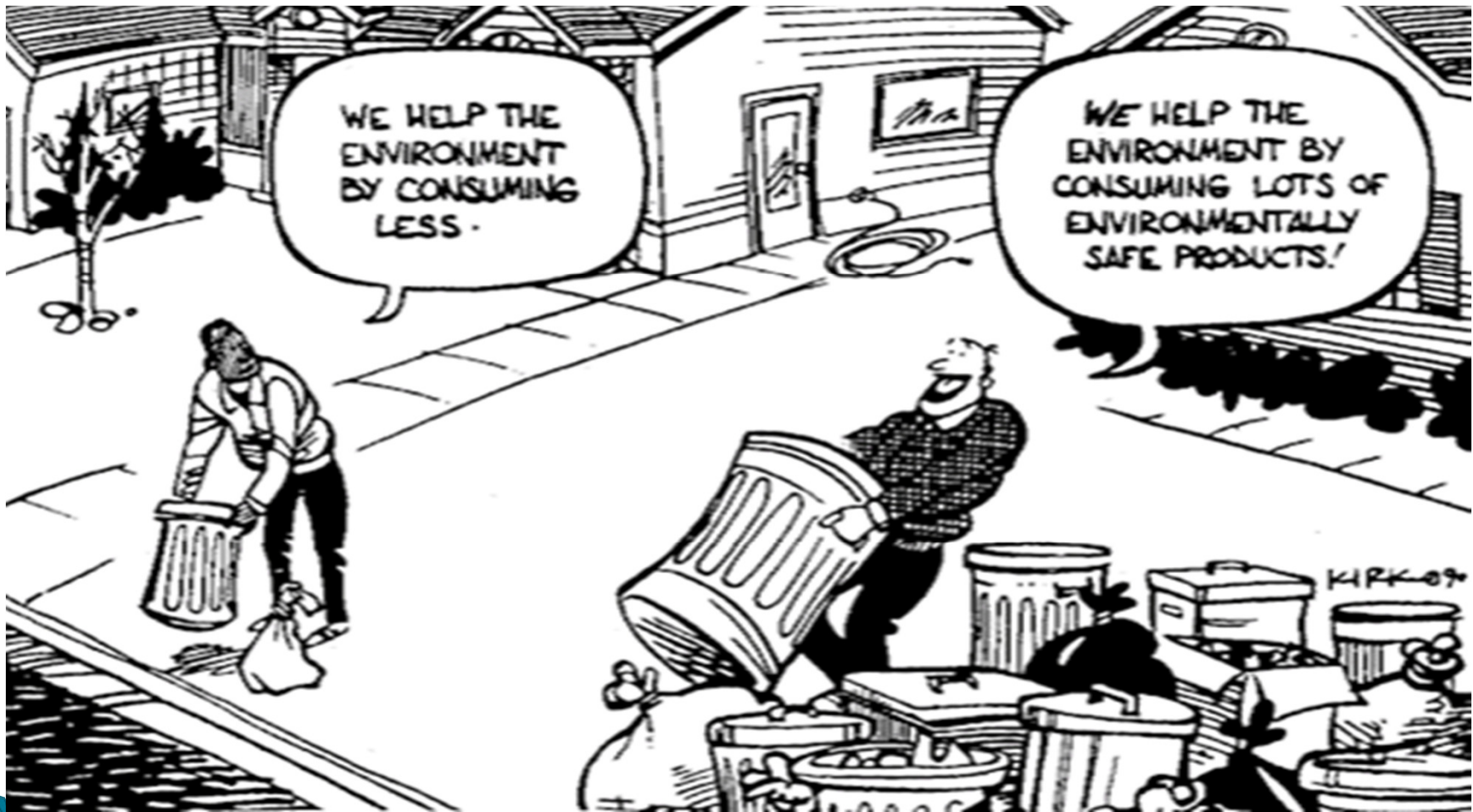

## Pollution Prevention questions:

- What's the real cause of the waste being created?
  - Can the step or process simply be eliminated?
  - Is there a non-toxic or less toxic material that can be used, instead?
  - Is there a way the process can be changed to make less waste or a less toxic waste?
  - Can the waste be reused or recycled?
- 

# What can you do?



# Education



# Swap Shop



# Save money!!!





# What is Pollution Prevention?

**Reducing or eliminating waste at the source by:**

- promoting the use of **non-toxic** or less-toxic substances,
- implementing **conservation** techniques,
- and **re-using** materials rather than putting them into the waste stream.

Questions???

# Contact Information:

**NHPPP@DES.NH.GOV**

Melissa Zych

603-271-6460

[melissa.zych@des.nh.gov](mailto:melissa.zych@des.nh.gov)

Cynthia Walthour

603-271-2956

[cynthia.walthour@des.nh.gov](mailto:cynthia.walthour@des.nh.gov)





# Implementing Pollution Prevention Strategies at Solid Waste Facilities

Tara Mae Albert, M.S.  
SWOT Coordinator

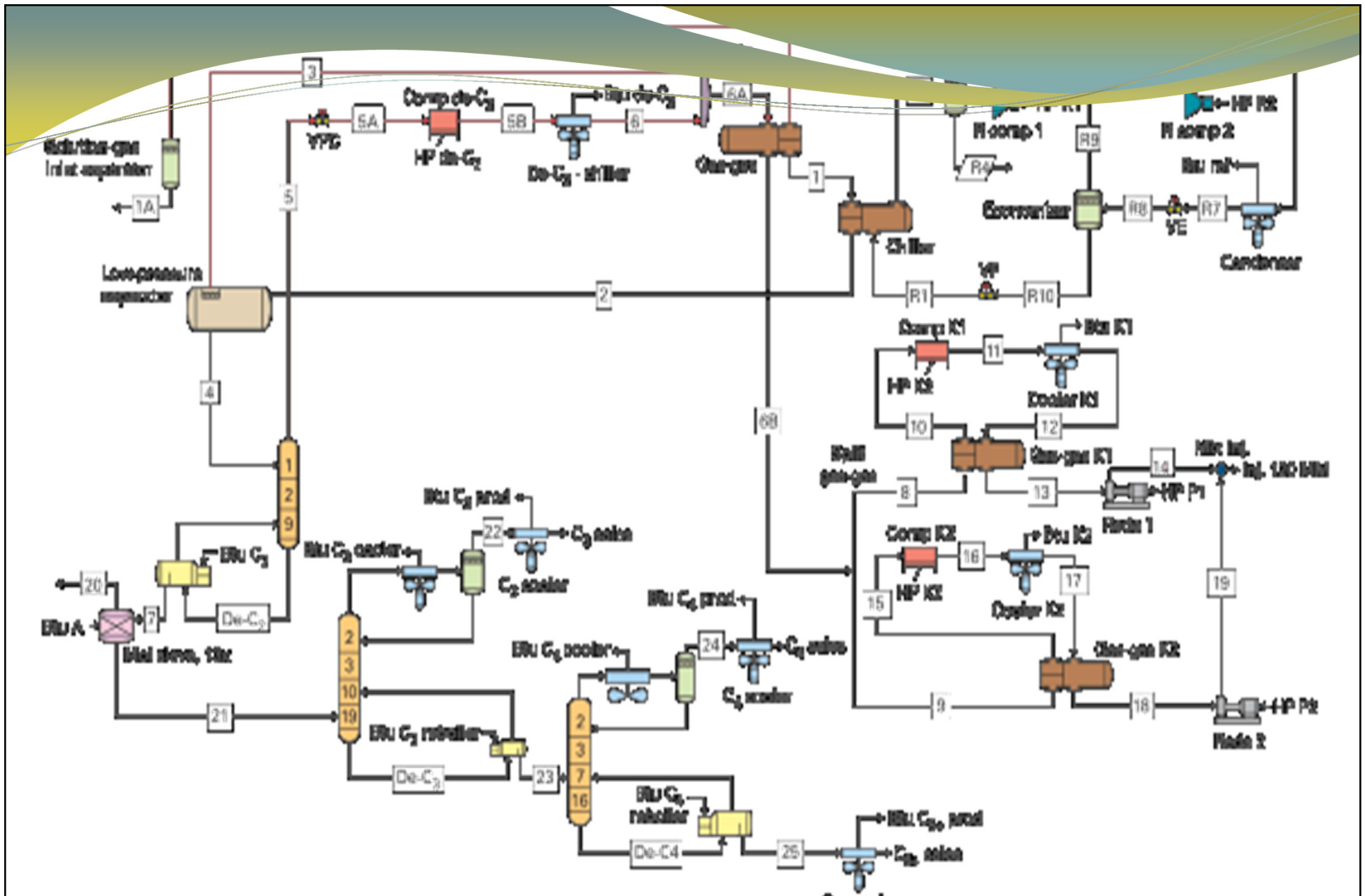

Process Flow Diagram

# Process Flow Diagram

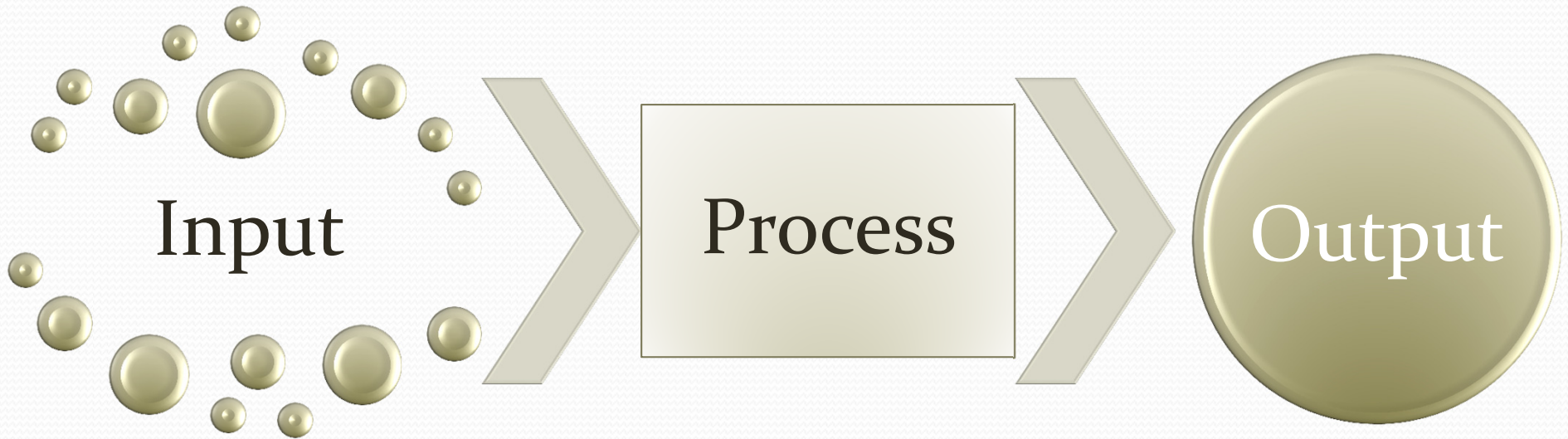

# Simple Process



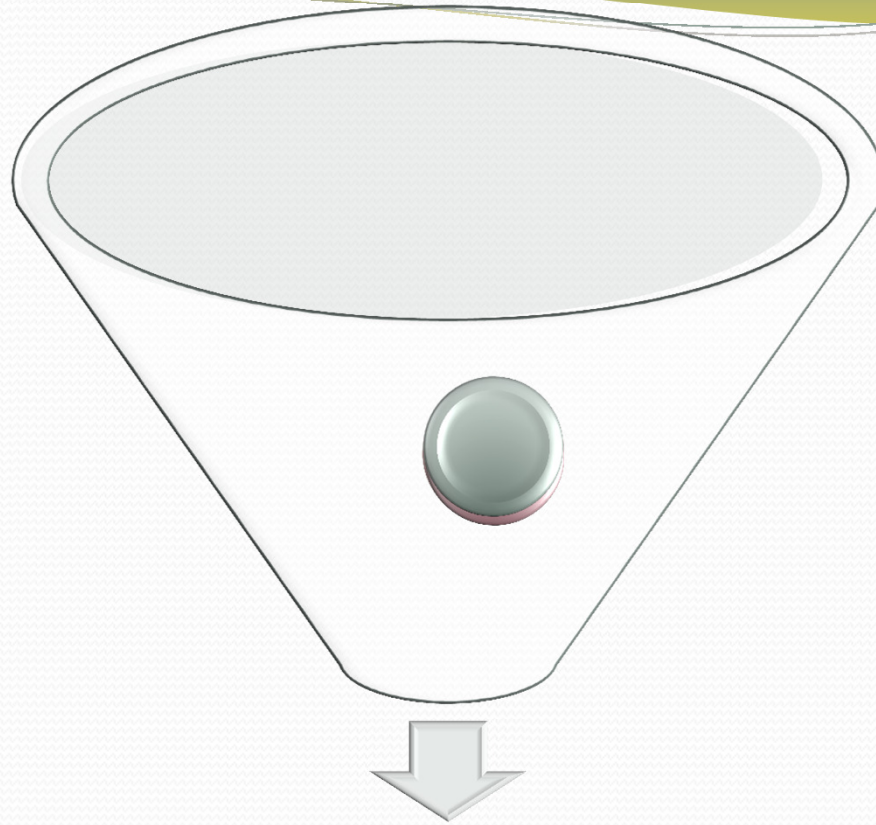

Dirty  
Water

Dirt

Other

Clothing



## Steps to Reduce the “unwanted” Outputs

- Shake out the dirt
- Empty Pockets
- Spot Check

## Steps to Reduce the “unseen” Wastes

- Full load of clothes
- Cold Water
- Use the appropriate amount of detergent

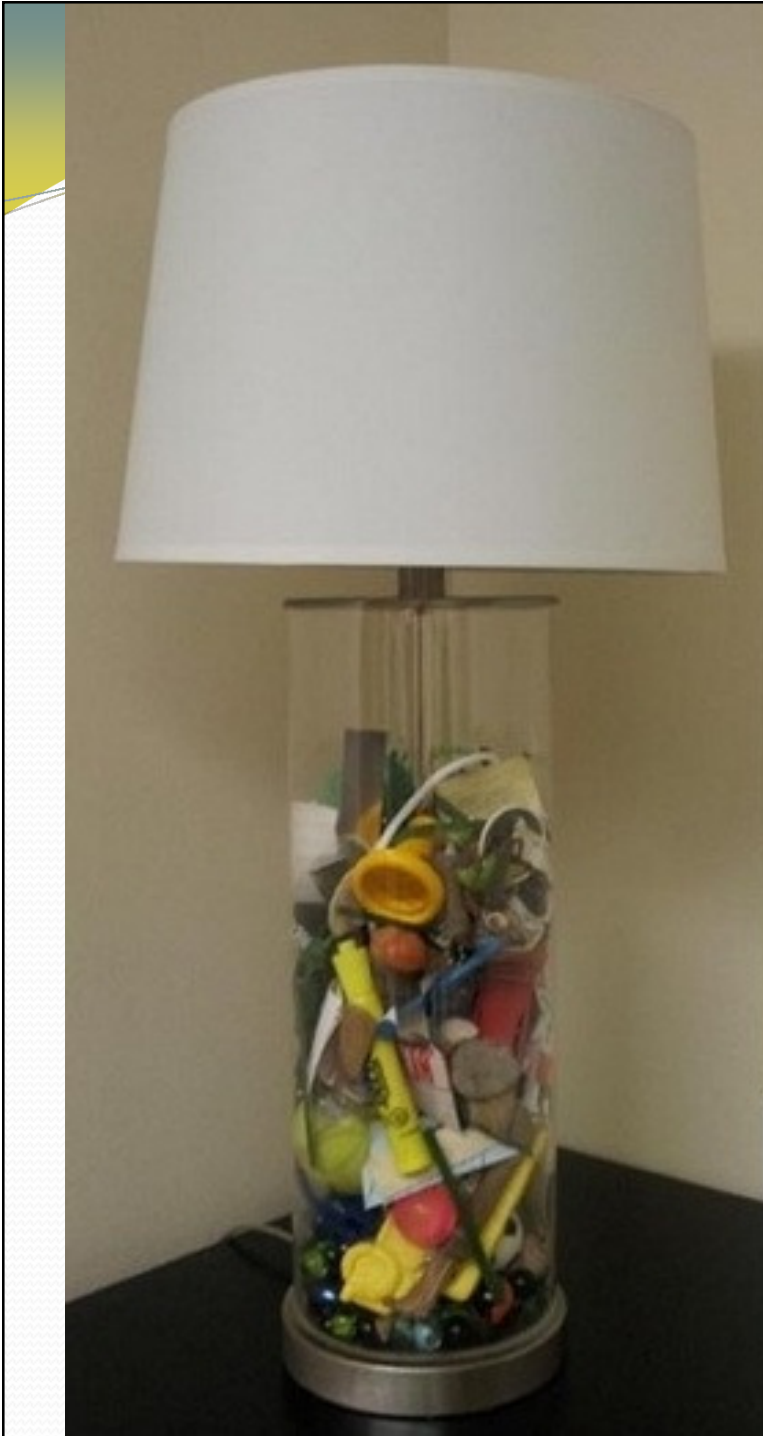

# “It’s the LAW!”

- Solid Waste Facilities are permitted by NHDES
- NHDES is authorized to permit by RSA 149-M (LAW)
- RSA 149-M states that NH’s goal is to achieve 40% weight diversion of SW landfilled or incinerated per capita by 2000.



Remember this...

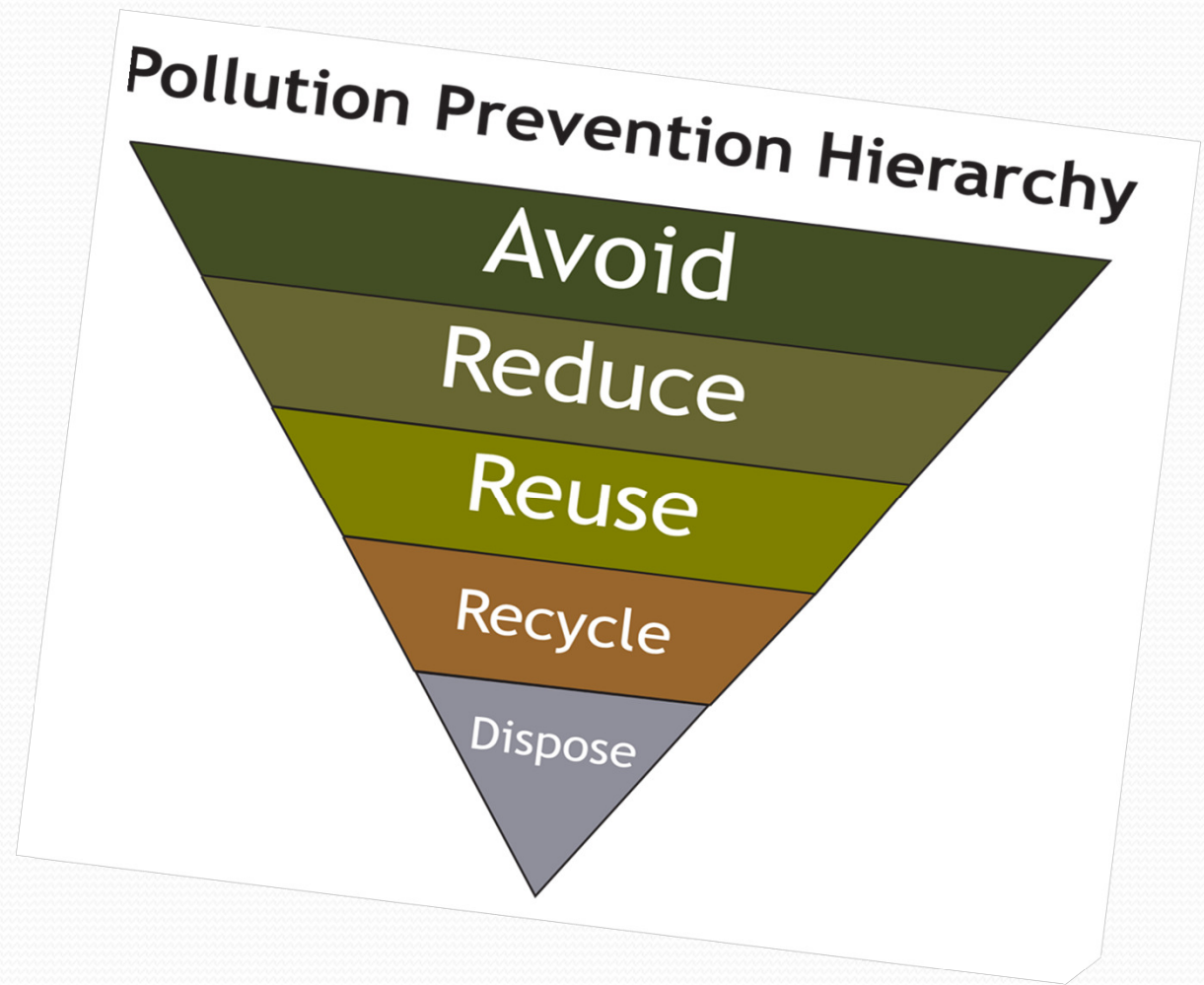

# Waste Management Hierarchy

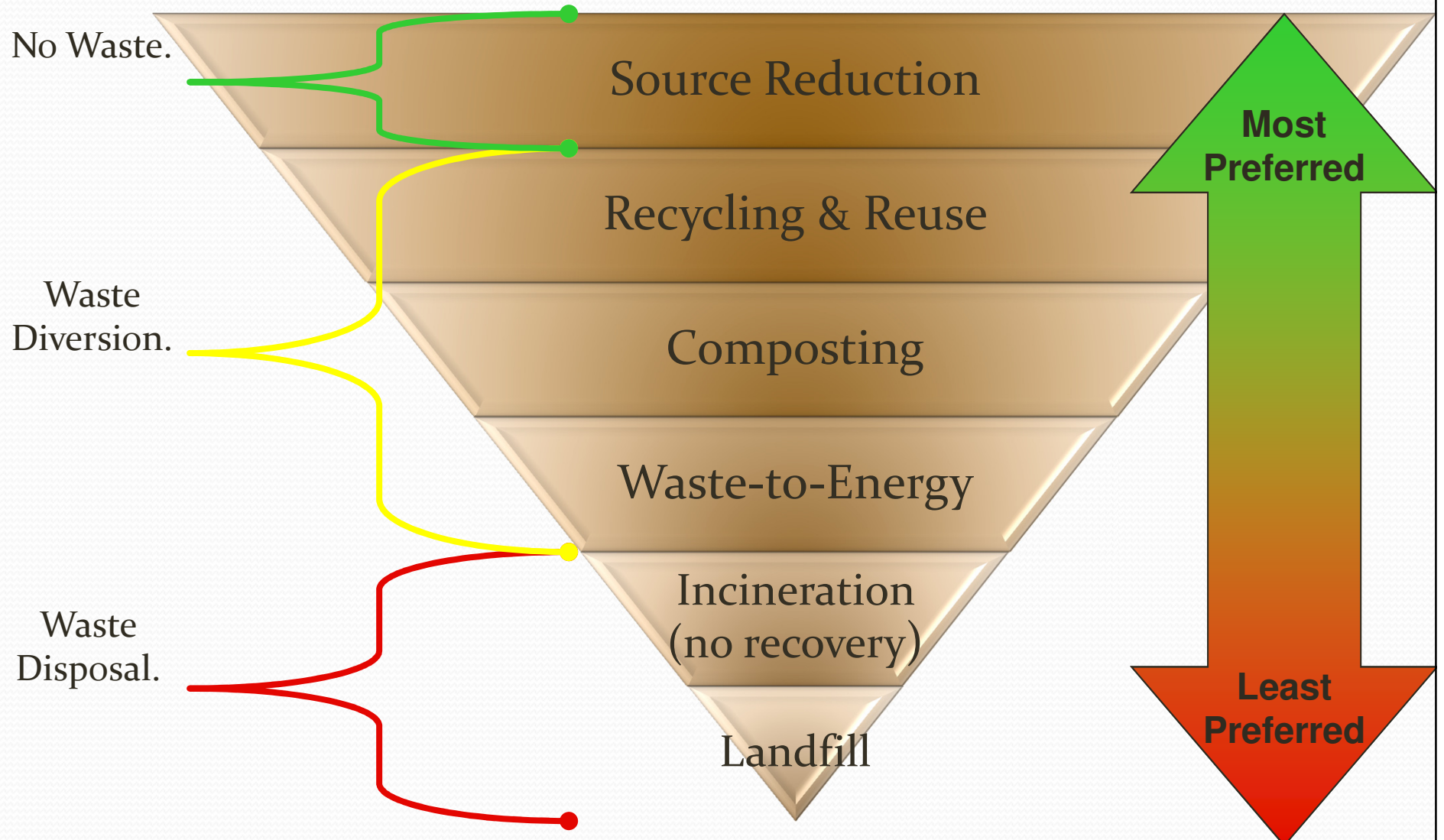

# Process Flow



# Transfer Station



## Waste In

- MSW
- Electronics
- “Good Stuff”
- HHW
- Used Oil
- Recyclables
- Putrescible



## “Process”

- Swap Shop
- Hopper
- Metal Pile
- Sharps
- Separated Recyclables
- Compost
- Landfill

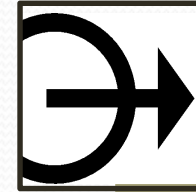

## Waste Out

- MSW: Disposal
- Customer’s Car: Reuse
- Plastic, metal, glass, etc.: Recycling
- Compost

## Rethink your Options

The point is to get the stuff out from the landfills and incinerators into more preferred methods of managing our wastes.

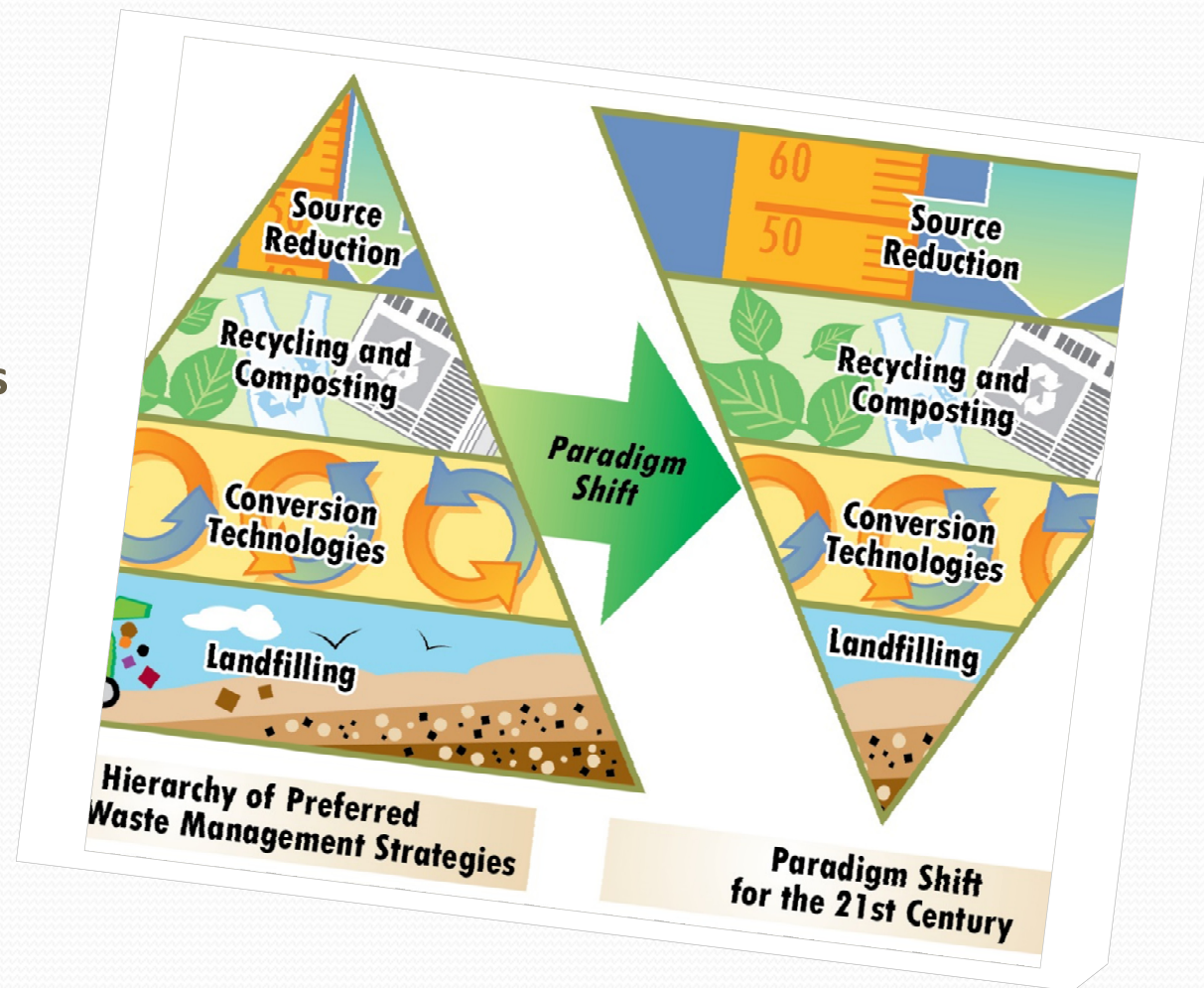

# What Can YOU Do?



Educate  
Your  
Fellow  
Operators



Partner  
with Your  
BOS or  
Managers



Educate  
Your  
Customers



Implement  
the  
Changes







**Thanks for  
listening!**

**Any Questions?**

**No?**

**SUPER!**

# What to do With Your (HHW) Gifts

Dean Robinson  
NH Department of Environmental Services

August 24, 2016







**Options**  
Just Ahead

# Disposal





PUBLIC

GOVERNMENT

BUSINESS

A to Z LIST

- [DES Home](#)
- [A to Z List](#)
- [About DES](#)
- [Media Center](#)
- [Public](#)
- [Government](#)
- [Business](#)
- [Programs](#)
- [Rules/Regulatory](#)
- [Contact Us](#)



**Beach Advisory**  
**Drinking Water Advisory**



Follow us on  
**twitter**



[Office of the Commissioner](#) > [Programs/Bureaus/Units](#) >

## Household Hazardous Waste Program

The Household Hazardous Waste (HHW) Program is working toward changing the way New Hampshire's residents purchase, use and dispose of hazardous products, with a goal of reducing the amount or "toxicity" of the products they purchase. We work extensively with homeowners and municipalities, so for your benefit all information on the HHW home page has been divided into those two categories. Please read more to learn what the HHW program is doing for New Hampshire's homeowners and municipal solid waste facilities. [more ...](#)

### Hot Topics

- [Residential Household Hazardous Waste Collections: : July 1, 2016 - June 30, 2017](#)
- [National Prescription Drug Take-Back Day](#)

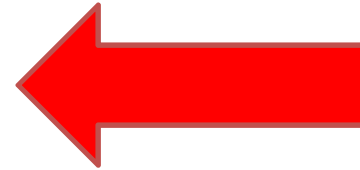

### Publications [\(Complete List\)](#)

- [Businesses/SOGs](#)
- [Homeowners](#)
- [Municipalities](#)

### Rules/Regulatory

- [Env-Hw 1000 Hazardous Waste Cleanup Fund](#)

### Education/Outreach

- [Audio Visual](#)
- [Curricula](#)
- [Videos For Loan](#)
- [Written Materials](#)

### Training [\(Complete List\)](#)

### Forms/Applications [\(Complete List\)](#)

- [Certificate of Authority Guidance](#)
- [HHW Collection Guidance](#)
- [HHW Grant Application](#)
- [HHW Invoice Checklist](#)
- [HHW Report Form](#)
- [Insurance Example](#)

### Grants/Loans [\(Complete List\)](#)

### FAQs [\(Complete List\)](#)

search this site

#### HHW Program

- [Program Home](#)
- [Overview](#)
- [Hot Topics](#)
- [Publications](#)
- [Rules/Regulatory](#)
- [Education/Outreach](#)
- [Training](#)
- [Forms/Applications](#)
- [Grants/Loans](#)
- [FAQs](#)
- [Contact Us](#)

#### Office of the Commissioner

- [Office Home](#)
- [Office Overview](#)
- [Programs/Bureaus/Units](#)
- [Publications](#)
- [Contact Us](#)

#### The Department

- [Commissioner's Office](#)
- [Air Resources Division](#)
- [Waste Management Div.](#)
- [Water Division](#)
- [Boards and Committees](#)

#### DES Calendar

				1	2	3
4	5	6	7	8	9	10
11	12	13	14	15	16	17
18	19	20	21	22	23	24
25	26	27	28	29	30	



TOWN	ORGANIZER	RELATED WEB-PAGE	CONTACT	GPS LOCATION	ADDRESS OF COLLECTION
Berlin	Androscogin Valley RRDD	<a href="http://www.uvlrpc.org/project/Household_Hazardous_Waste_Collections_9/">http://www.uvlrpc.org/project/Household_Hazardous_Waste_Collections_9/</a>	603-752-3342	44.511885,-71.239046	100 West Milan Road, Berlin
Albany	Conway	<a href="http://conwaynh.org/public-works/">http://conwaynh.org/public-works/</a>	603-447-3811 X23	44.011035,-71.059216	755 East Conway Road, Center Conway
Alexandria	Lakes Region Planning Commission	<a href="http://www.lakesrpc.org/services_hhw.asp">http://www.lakesrpc.org/services_hhw.asp</a>	603-279-8171	43.444507,-71.477398	Belmont Fire Station, 14 Gilmanton Road, Belmont
	Lakes Region Planning Commission	<a href="http://www.lakesrpc.org/services_hhw.asp">http://www.lakesrpc.org/services_hhw.asp</a>	603-279-8171	43.444215,-71.65117	Franklin Public Works Garage, 43 West Bow Street, Franklin
	Lakes Region Planning Commission	<a href="http://www.lakesrpc.org/services_hhw.asp">http://www.lakesrpc.org/services_hhw.asp</a>	603-279-8171	43.550982,-71.403269	Gilford Public Works Garage, 55 Cherry Valley Road, Gilford
	Lakes Region Planning Commission	<a href="http://www.lakesrpc.org/services_hhw.asp">http://www.lakesrpc.org/services_hhw.asp</a>	603-279-8171	43.670518,-71.505302	Mededith Public Works Garage, 15 Jenness Hill Road, Meredith
	Lakes Region Planning Commission	<a href="http://www.lakesrpc.org/services_hhw.asp">http://www.lakesrpc.org/services_hhw.asp</a>	603-279-8171	43.598388,-71.722208	NH DOT Highway Garage, 100 Ayers Island Road, Bristol
	Lakes Region Planning Commission	<a href="http://www.lakesrpc.org/services_hhw.asp">http://www.lakesrpc.org/services_hhw.asp</a>	603-279-8171	43.534371,-71.465100	Laconia Public Works Garage, 27 Bisson, Ave., Laconia
	Lakes Region Planning Commission	<a href="http://www.lakesrpc.org/services_hhw.asp">http://www.lakesrpc.org/services_hhw.asp</a>	603-279-8171	43.752582,-71.151261	Ossipee Town Highway Garage, 55R Main Street, Ossipee
	Lakes Region Planning Commission	<a href="http://www.lakesrpc.org/services_hhw.asp">http://www.lakesrpc.org/services_hhw.asp</a>	603-279-8171	43.723545,-71.422527	Moultonborough Town Highway Garage, 68/30 Highway Garage Road, Moultonborough
Alton	Wolfeboro	<a href="http://www.wolfeboronh.us/Pages/WolfeboroNH_Hazardous/index">http://www.wolfeboronh.us/Pages/WolfeboroNH_Hazardous/index</a>	603-651-7530	43.632247, -71.206740	Lakes Region Household Hazardous Product Facility, 404 Beach Pond Road Wolfeboro
	Wolfeboro	<a href="http://www.wolfeboronh.us/Pages/WolfeboroNH_Hazardous/index">http://www.wolfeboronh.us/Pages/WolfeboroNH_Hazardous/index</a>	603-651-7530	43.632247, -71.206740	Lakes Region Household Hazardous Product Facility, 404 Beach Pond Road Wolfeboro
Amherst	Nashua RPC	<a href="http://www.nashuarpc.org/hhw/">http://www.nashuarpc.org/hhw/</a>	603.424.2240	42.748327,-71.503358	Nashua Public Works Garage, 9 Stadium Drive, Nashua
Andover	Lakes Region Planning Commission	<a href="http://www.lakesrpc.org/services_hhw.asp">http://www.lakesrpc.org/services_hhw.asp</a>	603-279-8171	43.444507,-71.477398	Belmont Fire Station, 14 Gilmanton Road, Belmont
	Lakes Region Planning Commission	<a href="http://www.lakesrpc.org/services_hhw.asp">http://www.lakesrpc.org/services_hhw.asp</a>	603-279-8171	43.444215,-71.65117	Franklin Public Works Garage, 43 West Bow Street, Franklin
	Lakes Region Planning Commission	<a href="http://www.lakesrpc.org/services_hhw.asp">http://www.lakesrpc.org/services_hhw.asp</a>	603-279-8171	43.550982,-71.403269	Gilford Public Works Garage, 55 Cherry Valley Road, Gilford
	Lakes Region Planning Commission	<a href="http://www.lakesrpc.org/services_hhw.asp">http://www.lakesrpc.org/services_hhw.asp</a>	603-279-8171	43.670518,-71.505302	Mededith Public Works Garage, 15 Jenness Hill Road, Meredith
	Lakes Region Planning Commission	<a href="http://www.lakesrpc.org/services_hhw.asp">http://www.lakesrpc.org/services_hhw.asp</a>	603-279-8171	43.598388,-71.722208	NH DOT Highway Garage, 100 Ayers Island Road, Bristol
	Lakes Region Planning Commission	<a href="http://www.lakesrpc.org/services_hhw.asp">http://www.lakesrpc.org/services_hhw.asp</a>	603-279-8171	43.534371,-71.465100	Laconia Public Works Garage, 27 Bisson, Ave., Laconia
	Lakes Region Planning Commission	<a href="http://www.lakesrpc.org/services_hhw.asp">http://www.lakesrpc.org/services_hhw.asp</a>	603-279-8171	43.752582,-71.151261	Ossipee Town Highway Garage, 55R Main Street, Ossipee
	Lakes Region Planning Commission	<a href="http://www.lakesrpc.org/services_hhw.asp">http://www.lakesrpc.org/services_hhw.asp</a>	603-279-8171	43.723545,-71.422527	Moultonborough Town Highway Garage, 68/30 Highway Garage Road, Moultonborough
Ashland	Pemi Baker SWD	Unavailable	pemibakerswd@yahoo.com	44.282156,-71.800654	1213 Mt. Eustis Road, Littleton

**LAKES REGION  
HOUSEHOLD HAZARDOUS  
PRODUCT FACILITY**

A Collaborative  
Effort

TOWN OF WOLFEBORO  
Department of Public Works  
"Striving for Excellence"  
REGION PLANNING COMMISSION  
DEPARTMENT OF ENVIRONMENTAL SERVICES

603-51-753

**Open May - October  
Third Saturday  
8:30 AM - 12:00 PM**

**Lakes Region Household  
Hazardous Product  
Facility**

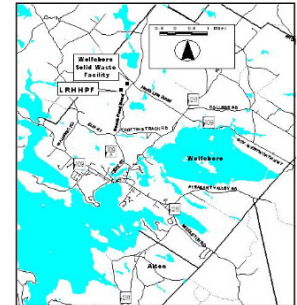

569 - 5826

569 - Let's Take Care Of it!

404 Beech Pond Road,  
Wolfboro, NH

Open May - October  
Third Saturday  
8:30 AM - 12:00 PM



## Paint Waste Collection and Recycling in New Hampshire

Household Hazardous Waste Collection / Solid Waste Management Facilities / Paint Recycling Programs

### New Hampshire Household Hazardous Waste Collection / Paint Recycling Programs

New Hampshire Municipal HHW Collection / Paint Recycling Programs :  
Concord, Dover, Manchester, Nashua, and Rochester



### Latex Paint Waste Management in New Hampshire

#### Household Hazardous Waste Collection / Solid Waste Management Facilities / Paint Recycling Programs - Paint Reuse Exchange

Many New Hampshire Hazardous Waste Collection agencies provide recycling services and waste collection events of recyclable products. The U.S. Environmental Protection Agency calculates that annually nearly 70 million gallons of paint are left over in the United States. Local New Hampshire communities and municipal agencies have historically managed leftover paint waste either through household hazardous waste (HHW) facilities or through solid waste management programs. Neither of these paint waste disposal methods resolve the increasing costs of disposal and landfill environmental hazards.

At GreenSheen, they have developed a cost-effective, environmentally sound, and feasible latex paint waste reduction program that can be applied to New Hampshire city and county landfill and Solid Waste Management Facilities.

GreenSheen operates latex paint waste management programs for municipal communities in New Hampshire providing disposal options that are environmental friendly and cost-effective recycling. They offer New Hampshire municipal agencies the opportunity to reduce their solid waste disposal and landfill costs with the added benefit of reducing their yearly paint procurement expenses. The paint recycling and reuse program recycles paint waste collected from households and remanufactures the leftover paint into new paint for local residents and municipal use. The program turns the thousands of tax dollars which are spent each year disposing of latex paint into cost-savings for New Hampshire communities and taxpayers.

Efficient recycling reuse programs in New Hampshire keeps paint waste out of county landfills. The Three R's: Reduce, Reuse and Recycle. Reuse

**CONTRACTORS FOR HOUSEHOLD HAZARDOUS  
WASTE COLLECTIONS PROJECTS  
2016-2017**

<p><b>Clean Harbors</b> 42 Longwater Drive Norwell, MA 02061 (781) 792-5000</p> <p>NH Field Service (603) 224-6626 <a href="http://www.cleanharbors.com">www.cleanharbors.com</a></p>	<p><b>Clean Venture</b> 133 Leland Street Frammingham, MA 01702 Phone: (508) 872-5000 Fax: (508) 875-5271 <a href="http://www.cyclechem.com">www.cyclechem.com</a></p>	<p><b>Care Environmental</b> 10 Oxden Drive Landing, NJ 07850 (800) 494-2273 <a href="http://www.careremediation.com">www.careremediation.com</a></p> <p>Local Office: 973-398-5100</p>	<p><b>Enpro Services, Inc.</b> 709 Keith Avenue Pembroke, NH 03275 603-410-11501-800-966-1102 <a href="http://www.enpro.com">www.enpro.com</a></p>
<p><b>Triumvirate Environmental</b> 61 Inner Belt Road Somerville, MA 02143 (888) 834-9697 <a href="http://www.triumvirate.com">www.triumvirate.com</a></p>	<p><b>New England Disposal Technologies, Inc.</b> 83 Gilmore Drive Sutton, MA 01590</p> <p>190 East Main (Route 20) Westfield, MA</p> <p>Office: 508-234-4440 Fax: 508-234-4441 <a href="http://www.NEDT.org">www.NEDT.org</a></p>	<p><b>APT Environmental Services, Inc.</b> P.O. Box 162 Milton, VT 05468 (802) 893-8281 <a href="http://aptsol.net">http://aptsol.net</a></p>	<p><b>Veolia Environmental Services</b> 398 Cedar Hill St Marlborough, MA 01752 (800) 354-2382 <a href="http://www.veoliaes.com">www.veoliaes.com</a></p>
<p><b>Complete Recycling Solutions</b> 1075 Airport Road Fall River, MA 02720 508-402-7714 <a href="mailto:sales@crsrecycle.com">sales@crsrecycle.com</a> <a href="http://www.crsrecycle.com">www.crsrecycle.com</a></p>	<p><b>Cyn Environmental</b> 8 Progress Drive Dover, NH 03820 603-749-4969 <a href="http://www.cynenv.com">http://www.cynenv.com</a></p>	<p><b>Tradebe Environmental Services</b> 410 Shattuck Way Newington, NH 03801 888-276-0885 <a href="http://www.tradebeusa.com">http://www.tradebeusa.com</a></p>	<p><b>USEcology</b> 185 Industrial Road Wrentham, MA 02093 (800) 426-9878 Office (508) 965-4820 Cell (508) 384-6028 Fax <a href="https://www.usecology.com/Locations/All-Locations/US-Ecology-Boston.aspx">https://www.usecology.com/Locations/All-Locations/US-Ecology-Boston.aspx</a></p>

**1) NHDES Web Page (other towns)**

**2) LRHHPF (Flyer)**

**3) Paintwastedisposal.com (Web Page)**

**4) Give it away or use it up**

**5) Private Haulers (Hand Out)**



# Overview of HHW & Practical Approaches to Alternative Products

Dean Robinson  
NH Department of Environmental Services

August 24, 2016







**5,600**

**180**



**IGNITABLE**

**I**



**CORROSIVE**

**CAN'T**



**REACTIVE**

**REMEMBER**



**TOXIC**

**THAT**

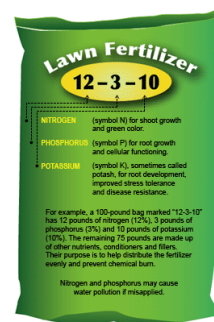



# Most Dangerous Items in Your Home

## Hydrocarbons & Solvents



- Agitation
- Confusion
- Coma
- Breathing difficulty
- Severe stomach pain
- Throat swelling
- Vomiting blood
- Blood in your stools
- Skin burns
- Vision loss
- Low blood pressure that develops rapidly

- Petroleum distillates - skin and lung cancer
- Nitrobenzene - Hemotoxin
- (absorbed through the skin)



# Most Dangerous Items in Your Home



## Ammonia & Hydrocarbons



- Vision loss
- Bloody stools
- Vomiting blood
- Collapse
- Coma
- Convulsions
- Necrosis (holes) in the skin or underlying muscle
- Kidney Failure
- Diethanolamine (DEA) Carcinogen
- Triethanolamine (TEA). Carcinogen
- 1,4-dioxane, Carcinogen
- Ethoxylated alcohols. Carcinogen
- Ethylene glycol monobutyl ether - Neurotoxic - damage to the brain and nervous system

# Most Dangerous Items in Your Home

## Sodium Hydroxide & Hydrogen Chloride



- Abdominal pain
- Throat swelling
- Collapse
- Loss of vision
- Mouth pain (severe)
- Rapid drop in blood pressure
- Throat pain (severe)
- Severe tissue damage
- Brain Damage
- Death



- Sodium hydroxide (lye)  
**(120-140 degrees)**  
heat dilution



April 19, 1995



# Fertilizer & Oil - Atlanta



# Officials: 2 killed, 80 homes affected after massive explosion in Indianapolis

By the CNN Wire Staff

🕒 Updated 10:22 AM ET, Mon November 12, 2012



Residents return to damaged homes 01:19

## Story highlights

Seven go to hospitals after the late-night blast in an Indianapolis neighborhood. officials say

It must be a bomb.

That was Debbie Wagner's first thought when she heard the boom as she lay in bed overnight Saturday in her

# Pool Chemicals - Chicago





## Pool Chemical Fire

### Pool Chemicals Fire

Chemaxx was hired to investigate pool chemicals believed to have been responsible for a sudden, unexpected vigorous fire. The tragic incident took place inside the rear of an SUV that was traveling with two parents in the front and three children in the back seat. It is believed that an aerosol product leaked an organic solvent that made contact with the pool chemicals. The mixture burst into flames that instantly engulfed the entire vehicle in flames. While the parents were just able to exit the vehicle they were not able to rescue all their children even though they received severe burns trying. Only one child was saved and two children perished in the fire. It just doesn't get any more horrific than this.







**Dean F. Robinson II**  
**New Hampshire Department of Environmental Services**  
**[dean.robinson@des.nh.gov](mailto:dean.robinson@des.nh.gov)**  
**Phone: (603) 271-2047**